

Multi-Mic+

User guide

Table of Contents

Introduction	3
Symbols	5
Getting to know your device	6
Using the device for the first time	12
Daily use	18
General warnings and cautions	26
Maintenance	29
Technical specifications	30
Regulatory information	31
Statement	33
Acknowledgements	35

Introduction

Read this booklet carefully before using the device. Ask your hearing care professional if you have any questions.

Intended purpose

The GN Hearing A/S Multi-Mic+ is intended to be a wireless remote microphone or connection to an audio device for wireless GN Hearing A/S hearing aids.

When used as a remote microphone, the Multi-Mic+ is placed close to a person or a sound source and sends the voice or sound directly to the hearing aid.

When used as a connection to an audio device, the Multi-Mic+ is connected to the audio device through cable, Telecoil or an FM adapter and the sound is sent directly to the hearing aid.

The GN Hearing A/S Multi-Mic+ may also be used together with Approved Cochlear Ltd or Cochlear Bone Anchored Solutions AB Partner Products.

Approved Partner Product refers to specific products released and marketed by Cochlear Ltd or Cochlear Bone Anchored Solutions AB partners.

Any Approved Partner Product compatibility will be subject to and the sole responsibility of partner.

Target group

The Multi-Mic+ is intended to be used by lay persons.

Therapeutic indications

The accessory has no therapeutic indications in itself.

Contra-indications

No known contra-indications.

Symbols

The symbols below are used in this user guide, on the device, or on the packaging.



CAUTION: Indicates a situation that could lead to minor and moderate injuries.



Date of manufacture.



Regulatory compliance mark for EU.



Catalogue number.

FCC ID

Device is subject to US certification.



Regulatory compliance mark for Japan.

CMIIT ID:
XXXxyzzz

CMIIT ID: XXXxyzzz



Follow local regulations when disposing of electronic devices.



WARNING: Points out a situation that could lead to serious injuries.



Legal manufacturer.



Follow instructions for use. (Logo in blue)



Unique Device Identification.



Serial number.



Regulatory compliance mark for Australia and New Zealand.



Regulatory compliance mark for Malaysia.



Equipment includes an RF transmitter.

Getting to know your device

Unpacking — box contents



Multi-Mic+

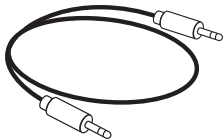

3.5 mm line-in/minijack
cable

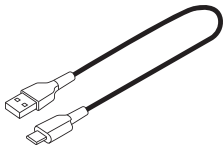

USB-A to USB-C cable
(used to supply power to
the device)

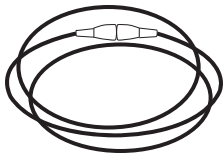

Lanyard

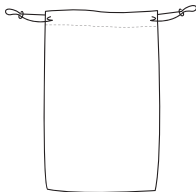

Carrying pouch

Description

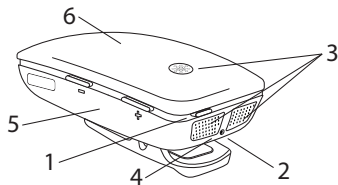

Front/top/side view

1. Power button
2. Status indicator LED
3. Microphones
4. Top
5. Side
6. Front

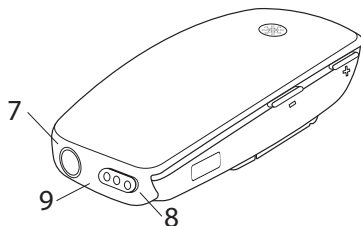

Front/bottom/side view

7. Minijack (line-in, 3.5 mm) socket
8. Socket for FM module
9. Bottom

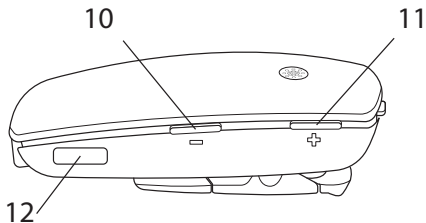

Front/side view

- 10. Volume decrease
- 11. Volume increase
- 12. USB-C socket

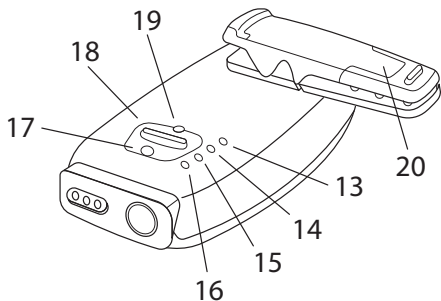















Back/bottom/side view



- 13. Microphone mode
- 14. Telecoil mode
- 15. Minijack (line-in, 3.5 mm) mode
- 16. FM (audio) mode
- 17. Rubber cover
- 18. Mode button
- 19. Pairing button
- 20. Mounting clip

LED information

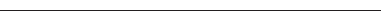
The LED on top of the device will show various colours and patterns in response to turning the device ON/OFF. Increasing/decreasing the volume, selecting one of the modes, pairing, and other options will be shown as LED flashes - see below table.

LED patterns	Process
	Powered OFF No LED
	Powered ON Short green LED flash every 2 seconds
	Powered ON (Volume control disabled) Short green, white LED flashes every 2 seconds
	Powered ON – low battery charge Short 3 green LED flashes every 2 seconds
	Powered ON – low battery charge (Volume control disabled) Short green, white, green LED flashes every 2 seconds
	Volume control locked or unlocked Green, blue, green LED flash

LED patterns	Process
	Turning power ON Green LED for 3 seconds
	Turning power OFF 3 white LED flashes
	Test mode Constant white LED
	Test mode Blue LED flashes every second
	Pairing successful Blue LED for 3 seconds
	Volume changes 1 white LED flash
	Boot error (service needed) Blue, white, green flashes every 2 seconds
	Connection lost 3 white LED flashes every 2 seconds
	Mode selected (TC/FM/Line-in/Mic) Green LED for 2 seconds
	Volume limit reached White LED for 2 seconds

LED patterns	Process
	Firmware update ongoing Blue, white, green LED flashes
	Firmware update successful Green LED flash for 1 second
	Factory reset 2 green LED flashes

Using the device for the first time

Only connect the Multi-Mic+ to connections for which it is explicitly intended.

It is recommended to fully charge the device before using.

To charge the device, use the supplied USB-A to USB-C cable and connect to a suitable power supply.

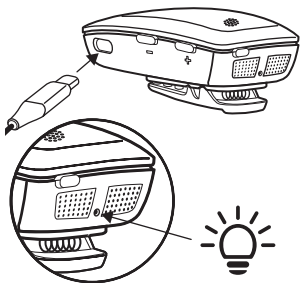

The charging status can be seen on the back of the device, with each solid or flashing LED (1) representing 25% charge (image shows 75% charge).

Charging may take 3 hours, depending on initial state of battery.

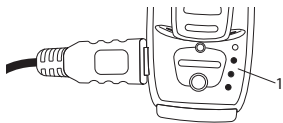

When the device is powered ON, to see the current battery status press and hold the Mode button (1) for at least 1 second until one or more of the Mode LEDs (2) starts to blink.

- 4 LEDs: 75-100 % remaining battery capacity
- 3 LEDs: 50-75 % remaining battery capacity
- 2 LEDs: 25-50 % remaining battery capacity
- 1 LED: <25 % remaining battery capacity.

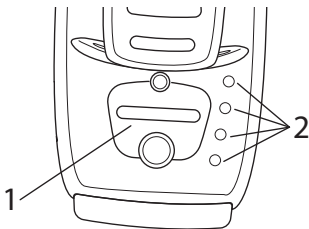

Battery warnings



WARNING:

- The battery used in this device may present a risk of fire or chemical burn if mistreated.
- Do not attempt to open the device or replace the battery. It is built-in and not changeable. Use of other batteries may present a risk of fire or explosion and the warranty will be terminated.
- The battery in your device can not be removed or replaced by the user. Any attempt to do so is risky and may result in damage to the device.
- Dispose of batteries according to local regulations. Please recycle when possible.

- Do not dispose of the battery as household waste or in a fire as it may explode.
- Batteries may explode if damaged.
- This device contains a lithium-ion battery. On rare occasions, lithium-ion batteries can become very warm. It is advisable to be attentive while charging.
- If the outer casing of your device is broken, the rechargeable batteries inside may leak. In this case, do not attempt to use the device – contact your hearing care professional.
- Battery leakage can cause chemical burns. If you get exposed to battery leakage material, rinse immediately with warm water. If you get chemical burns, redness or skin irritation from battery leakage, seek medical attention.
- For safety reasons, only use the charging cable supplied with the device.
- When you disconnect the power cord or any enhancement, grasp and pull the plug, not the cord.
- Avoid charging the device in extremely high or low temperatures.
- Do not charge the device while it is on your body.

NOTE:

- Your device is powered by a rechargeable battery.
- The full performance of a new battery is achieved only after two or three complete charge and discharge cycles.
- The battery can be charged and discharged hundreds of times but will eventually wear out.
- Unplug the charger from the electrical plug and the device when not in use.
- If left unused, a fully charged battery will lose its charge over time.

- Leaving the device in hot places, such as in a closed car in the summer conditions, will reduce the capacity and lifetime of the battery.
- A device with a cold battery may not work temporarily, even when the battery is fully charged. Battery performance is particularly limited in temperatures well below freezing point.
- For the availability of approved enhancements, please check with your hearing care professional.
- Charge the device according to the instructions supplied with the device.

Turning the device ON and OFF

To turn the device ON, press and hold the Power button for approximately 2 seconds, until the status LED turns green. After releasing the Power button, the status LED will blink green every 2 seconds.

To turn the device OFF, press and hold the Power button for approximately 2 seconds, until the status LED turns off.

Pairing the device to your hearing aids

To transmit sound from the device to your hearing aids you need to pair the device to your hearing aids.

NOTE: To avoid accidental pairing, turn off all other nearby hearing aids. If it is not possible to turn off the hearing aids not to be paired, place them at least 1 metre (3 feet) from the device.

To pair the devices

1. Place the hearing aids within 5 cm (2 inches) of the Multi-Mic+. Ensure the hearing aids and the Multi-Mic+ are powered ON.
2. You may use a pen tip or similar object to press on the pairing button. After you press the pairing button on the Multi-Mic+ it will start blinking blue.

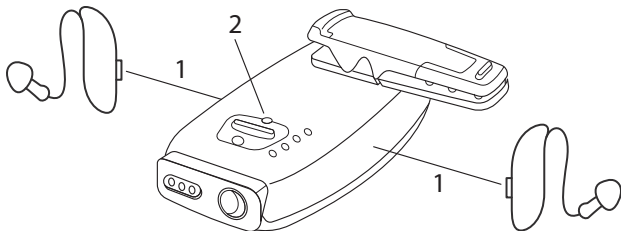

3. The hearing aids will be paired one at the time.
4. When the first hearing aid is paired, you will see a blue LED for 3 seconds on the top of the Multi-Mic+.
5. The Multi-Mic+ will then start blinking again as it searches for another hearing aid. When another hearing aid is paired the same blue LED will be shown for 3 seconds. It will then blink blue again searching for more hearing aids.
6. When no other hearing aids are found, the LED on the top of the Multi-Mic+ will blink green to indicate it is powered ON.
7. After pairing with your hearing aids, when powered ON, streaming sound to your hearing aids is enabled by a long press on your hearing aids or via the app.

8. Streaming sound can be disabled via turning OFF the device, or a long press on the hearing aid, or selecting the function in the app.

Placement of the device

The device can be worn by a single speaker via the clipping the device to an item of clothing close to the speaker's head or fixed to a lanyard worn around the speaker neck.

1. For best results, the microphones should be pointed towards the speaker and about 10-40 cm (4-16 inches) from the speaker's mouth.

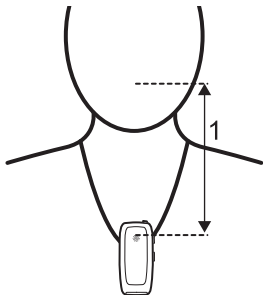

The device may also be placed on a table for meetings - the device will detect that it is placed on a horizontal surface and automatically switch to table mode.

Daily use

Adjusting the volume

The sound level is set to provide a comfortable listening level from the moment it is activated. However, for your convenience, you may adjust the sound level at any time.

For some devices or listening environments you may want to adjust the volume. This can be done by:

- Use the '+' and '-' buttons on the device (volume adjustments apply to the streamed signal only). Every volume change on the device will be indicated by a short blink of the Power LED.
- Using your hearing aid sound volume buttons.
- Using the App paired to your hearing aids.
- Using a remote control paired to your hearing aids.

NOTE: The device will revert to its default level for all modes when restarted.

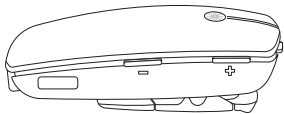

Other audio sources

You can use the device with other devices that have compatible outputs such as a personal computer or other audio systems.

The device has sockets to receive cables from analogue (minijack/line-in) and FM. When a cable is connected to a socket, the device will automatically select the appropriate mode.

Connecting the device and hearing aid App

The device can be controlled via the same app that supports your hearing aids.

This will allow you to start and end the streaming and to adjust volume from the app.

If necessary, the app will provide notifications of firmware updates and product enhancements.

Download the app or ask your hearing care professional for more information.

NOTE: Partner supplied devices may not have the same app functionality.

Phone calls

When using the device, you can still receive phone calls if your hearing aids are connected to your mobile device.

You will hear an alert in your hearing aids to signal an incoming call and your hearing aids will automatically stop the audio signal from the device if you choose to answer the incoming call – refer to your hearing aid or partner device user guide for more information on how to accept phone calls. The hearing aids automatically switch back to the device audio signal after the phone call ends.

Range

The streaming range from device to hearing aids is up to 25 metres (82 feet), depending on hearing aid. You do not have to have the device in your view, you can be in another

room. However, environmental interference like walls or furniture may reduce the operating range.

If the hearing aids are out of range of the device the audio transmission will stop. Once the hearing aids are back into the range of device, the audio signal will automatically resume streaming.

There is a time limit of 5 minutes for automatic reconnection. If you are out of range for more than 5 minutes you will have to restart the streaming manually via your hearings aids or the app.

This device includes an RF transmitter that operates in the frequency range of 2.4 GHz to 2.48 GHz.

Mode/battery charge button

The Mode button is used to view current mode, switch between different input modes, and check the battery status.

Current mode: To view the current mode of operation, press the Mode button once. The corresponding mode LED on the back of the device will light up for 3 seconds.

To change between the microphone, telecoil, minijack (line-in), and FM modes:

1. Pressing the Mode button once will cause the corresponding LED to be lit.
2. Within 3 seconds, press the Mode button again to change mode.
3. Repeat step 2 until the desired mode is obtained.



Modes

The Multi-Mic+ is a versatile speech and audio streamer offering both microphone pickup while worn vertically on the body, or as a table microphone while placed horizontally on

e.g. a table. It also offers extended audio source connectivity options by being able to receive telecoil signals, FM signals (optional FM receiver needed) and connecting to auxiliary audio sources through the built-in mini-jack line input.

It is possible to stream speech and audio in the following ways:

 Microphone	<p>From the built-in microphones In microphone mode the Multi-Mic+ will send sound from the environment to the hearing instruments. The Multi-Mic+ will optimize the speech pick-up depending on how it is used. When wearing it vertically on the body (using the clip or the lanyard) the Multi-Mic+ will be in a mode, minimizing background noise.</p> <p>When placed horizontally on a table, the Multi-Mic+ will switch into an optimized Table mode, enabling pick-up of speech from more speakers placed around the unit.</p>
T Telecoil	<p>From the built-in Telecoil, receiving audio from a teleloop system (available at e.g. some theatres, schools, churches, etc.). Note: Telecoil mode will not be available when the Multi-Mic+ is charging.</p>

 Analogue/Line-in	From an external, analogue audio source. In line-in mode the Multi-Mic+ can receive audio from an audio device such as a mobile phone, MP3 player, tablet, computer or TV. To use this mode, the audio device must be connected to the Multi-Mic+ using a mini-jack cable (included with the Multi-Mic+). When an audio device is connected, line-in mode will automatically be selected. Other modes can be selected by clicking on the mode button until the desired mode is reached. In this mode, the hearing aid user will wear the Multi-Mic+ or have it nearby.
 FM receiver	From an external FM receiver. In FM mode the Multi-Mic+ can receive audio from a FM transmitter. This requires that an FM receiver (optional accessory) is attached to the Multi-Mic+ via the 3-pin Euro pin connector. When the receiver is inserted the FM mode will automatically be selected. Other modes can be selected by clicking on the mode button until the desired mode is reached. In this mode the hearing aid user will wear the Multi-Mic+ or have it nearby. The Multi-Mic+ will now be able to transmit the received FM signal to the hearing instruments.

NOTE: Line-in and FM modes can only be selected if a cable or an FM receiver is inserted into the Multi-Mic+.

Special features

Drop detection

If the device falls from a height of more than 75 cm (30 inches), a built-in sensor will mute the output streamed to the hearing aids for up to 2 seconds. This is done to protect the hearing aid user from very loud impact noises.

Volume control lock

The volume of the device can be locked to a specific level.

The volume level can be locked for all modes. When the volume control is locked, it will be fixed to the level it had when the device was powered OFF.

How to lock the volume control:

- Make sure the device is turned OFF.
- Press and hold the volume '-' button and the Power ON button for 2 seconds - until the status LED turns green and then release the Power button.
- Keep pressing the volume '-' button until a green-blue-green LED sequence flashes once.

How to unlock the volume control:

- Make sure the device is turned OFF.
- Press and hold the volume '+' button and the Power ON button for 2 seconds until the status LED turns green and then release the Power button.
- Keep pressing the volume '+' button until a green-blue-green LED sequence flashes once.

Table mode

The device becomes a general purpose microphone when placed clip down on a table or other level surface, receiving sound from many directions.

Test mode (for Hearing Care Professionals only)

The Test mode is primarily intended to be used for pediatric transparency measurements. The transparency measurement evaluates if the hearing aid and wireless (remote) microphones provide equal outputs when presented with the same 65 dB SPL input stimulus.

When in Test mode the microphone is set to omnidirectional mode with 0 dB gain when placed horizontally in the test chamber. Please refer to relevant guidelines for performing transparency measurements.

How to enter Test mode:

- Make sure the device is turned OFF and no power cable is attached.
- Press and hold the volume '-' and '+' buttons and the Power ON button for 2 seconds until the status LED turns green and then release the Power button.
- Keep pressing the volume '-' and '+' buttons until the status LED shows constant white after 10 seconds.
- When in Test mode the Status LED will be white.
- When entering Test mode the default volume is applied. If needed, volume can be adjusted on the device until transparency has been verified.
- To exit Test mode and save settings, turn off the device.

NOTE: Adjustments to reach transparency can be made on the Multi-Mic+.

Resetting the device

The device can be reset to factory default settings.

To do a reset to factory settings, press and hold the pairing button for 10 seconds.

General warnings and cautions



WARNING:

- Young children can wrap cords and lanyards/key chains around their neck causing the risk of strangulation. Therefore, always keep cords and lanyards/key chains out of reach of children.
- Do not dry your device in an oven, microwave oven or other heating equipment.
- The device contains a Lithium-ion battery. Consult your airline for details regarding the transportation of your Multi-Mic+.
- Always supervise children or individuals with cognitive, intellectual, or mental health challenges using their devices.
- Seek assistance in case of injury or sore on/in the body before using the device.
- Always use the latest available software update for your device.
- If your Multi-Mic+ is broken, do not use it - contact your hearing care professional.
- Keep your hearing aids and devices, along with any parts, batteries, and magnets, away from pets, children, and people with cognitive, intellectual, or mental health challenges.
- Seek immediate medical help if a hearing aid, a device, their parts, battery, or magnets, are swallowed, as it can cause choking and harm your health.
- Never use a device that has indications that it might have been damaged, modified, or tampered with by an unauthorised person.
- The Multi-Mic+ may be interfered with by other equipment.
When using the Multi-Mic+ and the device is affected by electromagnetic interference, move away from the source.

- When using wireless functions, your Multi-Mic+ sends low-powered digitally coded transmissions to communicate with other wireless devices. It is possible, but not likely, that other electronic devices will be affected. If this happens, move the Multi-Mic+ away from the affected device.
- External devices connected to the electrical input must be safe according to the requirements of IEC 60601-1:2005+A1:2012+A2:2020-1, IEC 60065, or IEC 60950-1, IEC 62368-1 as appropriate.
- No modification of this device is allowed.
- Keep the device and any cords and cables away from operating machinery.
- If the device experiences overheating, dropping, damage, or immersion in liquid, or its power adaptor, cable or plug is damaged, stop using it and contact your hearing care professional.
- Do not use in areas where there are explosive hazards or where there is a danger of ignition of flammable gasses.
- Avoid exposing your device to rain, moisture or other liquids to protect against damage to the device or injury to you.



CAUTION:

- X-ray radiation (e.g. CT scans, MRI scans) may adversely affect the correct functioning of this device. We recommend that you switch the device OFF before undergoing X-ray procedures and keep it outside the room.
- When boarding a flight or entering an area where RF transmitters are prohibited, deactivate wireless functionality.
- High-powered electronic equipment, larger electronic installations, and metallic structures may significantly reduce the operating range.

- If the hearing aids do not respond to the device because of an unusual field disturbance, move away from the disturbing field.
- Use only GN Hearing A/S original accessories.
- Do not use this device in locations where it is forbidden to use electronic devices.
- Your hearing aids and this device were given a unique communication code during the fitting. This ensures that the device will not affect hearing aids worn by others.
- The Multi-Mic+ may only be repaired by an authorized service centre.
- Opening or modifying the Multi-Mic+ might damage it. If problems occur which cannot be resolved by following the remedy guidelines in the troubleshooting section of this user guide, consult your hearing care professional.

Maintenance

Cleaning

Clean the device using a damp cloth. Never use house-hold cleaning products (washing powder, soap, etc.) or alcohol to clean the device.

- When Multi-Mic+ is not in use, turn it OFF and store it safely.
- Protect Multi-Mic+ from excessive moisture (bathing, swimming) and heat (radiator, car dashboard). Protect it from excessive shock and vibration.
- Protect the microphone and charger inlets from debris and dirt. If necessary, use the cleaning brush provided with your hearing aids to clean these areas.



WARNING:

- If you use a drying agent, only use recommended products.

Servicing

This device cannot be serviced nor repaired in the home. Please contact your local hearing care professional for assistance if the device fails to function as expected.

Technical specifications

Dimensions	
Length x width x height	63.5 x 29.9 x 23.8 mm (2.5" x 1.2" x 0.9")

Operational Conditions	
Operating range	Up to 25 metres (82 feet)
Power supply	Built-in rechargeable battery. Recharged via USB-C port
Wireless	2.4 GHz
Nominal RF output power transmitted	maximum 8.75 dBm
Operating temperature range	5 °C to 40 °C (41 °F to 104 °F)

Temperature conditions	
Storage temperature range	Minus 20 °C to 60 °C (minus 4 °F to 140 °F)
Temperature testing	The device is subject to various tests in temperature and damp heating cycling between minus 25 °C and 70 °C according to internal and industry standards.

Regulatory information

Warranties and repairs

The SM-3P is covered by a limited warranty issued by the manufacturer for a period of 12 months from the day of the original purchase. Please notice that extended warranties may apply in your country. Please contact your local hearing care professional for more information.

What is covered by this warranty

Any electrical component, that because of workmanship, manufacturing or design defects fails to function properly under normal use during life of this warranty will be replaced or repaired at no charge for parts or labour when returned to the point of purchase.

If it is determined that repair is not feasible, the entire unit may be replaced with an equivalent unit upon mutual agreement of the hearing care professional and the customer.

What is not covered by this warranty

Problems arising from improper handling or care, excessive use, accidents, repairs made by an unauthorized party, exposure to corrosive conditions or damage due to foreign objects entering the device are NOT covered by the limited warranty and may void it. The above warranty does not affect any legal rights that you might have under applicable national legislation governing sale of consumer products. Your hearing care professional may have issued a warranty that goes beyond the clauses of this limited warranty. Please consult your hearing care professional for further information.

Expected service life time

The expected service life time for the device is a minimum of 5 years.

Statement

This device complies with Part 15 of the FCC Rules.

Operation is subject to the following two conditions: (1) this device may not cause harmful interference, and (2) this device must accept any interference received, including interference that may cause undesired operation.

This Class B digital apparatus complies with Canadian ICES-003.

Note. This equipment has been tested and found to comply with the limits for a Class B digital device, pursuant to part 15 of the FCC Rules. These limits are designed to provide reasonable protection against harmful interference in a residential installation. This equipment generates, uses and can radiate radio frequency energy and, if not installed and used in accordance with the instructions, may cause harmful interference to radio communications. However, there is no guarantee that interference will not occur in a particular installation. If this equipment does cause harmful interference to radio or television reception, which can be determined by turning the equipment off and on, the user is encouraged to try to correct the interference by one or more of the following measures:

- Reorient or relocate the receiving antenna.
- Increase the separation between the equipment and receiver.
- Connect the equipment into an outlet on a circuit different from that to which the receiver is connected.
- Consult the dealer or an experienced radio/TV technician for help.

Changes or modifications can void the user's authority to operate the equipment.

This device is in compliance with the following regulatory requirements

- In EU: The device conforms to the General Safety and Performance Requirements according to Annex I of the EU Medical Device Regulation 2017/745 (MDR).
- Hereby GN Hearing A/S declares that the radio equipment type SM-3P is in compliance with Directive 2014/53/EU. The full text of the EU declaration of conformity is available at the following internet address:
www.declarations.resound.com/en
- In US: FCC CFR 47 Part 15, subpart C.

Model: SM-3P; FCC ID: X26SM-3P; IC: 6941C-SM-3P.

For other identified applicable international regulatory requirements in countries outside the EU and USA, please refer to local country requirements for those areas.

Acknowledgements

Portions of this software are written by Kenneth MacKay (micro-ecc) and licensed under the following terms and conditions:

Copyright © 2014, Kenneth MacKay. All rights reserved.

Redistribution and use in source and binary forms, with or without modification, are permitted provided that the following conditions are met:

- Redistributions of source code must retain the above copyright notice, this list of conditions and the following disclaimer.
- Redistributions in binary form must reproduce the above copyright notice, this list of conditions and the following disclaimer in the documentation and/or other materials provided with the distribution.

THIS SOFTWARE IS PROVIDED BY THE COPYRIGHT HOLDERS AND CONTRIBUTORS "AS IS" AND ANY EXPRESS OR IMPLIED WARRANTIES, INCLUDING, BUT NOT LIMITED TO, THE IMPLIED WARRANTIES OF MERCHANTABILITY AND FITNESS FOR A PARTICULAR PURPOSE ARE DISCLAIMED. IN NO EVENT SHALL THE COPYRIGHT HOLDER OR CONTRIBUTORS BE LIABLE FOR ANY DIRECT, INDIRECT, INCIDENTAL, SPECIAL, EXEMPLARY, OR CONSEQUENTIAL DAMAGES (INCLUDING, BUT NOT LIMITED TO, PROCUREMENT OF SUBSTITUTE GOODS OR SERVICES; LOSS OF USE, DATA, OR PROFITS; OR BUSINESS INTERRUPTION) HOWEVER CAUSED AND ON ANY THEORY OF LIABILITY, WHETHER IN CONTRACT, STRICT LIABILITY, OR TORT (INCLUDING NEGLIGENCE OR OTHERWISE) ARISING IN ANY WAY OUT OF THE USE OF THIS SOFTWARE, EVEN IF ADVISED OF THE POSSIBILITY OF SUCH DAMAGE.

Manufacturer according to EU
Medical Device Regulation
2017/745:

 GN Hearing A/S
Lautrupbjerg 7
DK-2750 Ballerup
Denmark

 Any serious incident that has occurred in relation to the device should be reported to the Legal manufacturer GN Hearing A/S and the competent authority of the EU Member State in which the user and/or patient is established.